

Push-to-Connect Fittings

*Celebrating
over
60 years
of service*



Hundreds of types of fittings can be used with plastic and rubber tubing and hose. Our goal at NewAge® Industries is to offer a good cross-section of fittings to efficiently connect our tubing and hose products. We suggest you use the Recommended Fittings & Clamps section found at each tubing and hose product to guide you in your fitting choices.

NewAge's push-to-connect fittings, called Newloc®, are available in both plastic and brass. Plastic (acetal) Newlocs offer durability with light weight and are available in both inch and metric sizes. Brass Newlocs provide higher temperature and pressure ratings. Newloc fittings work best with rigid and semi-rigid tubing, but may also be used with softer walls.

NewAge also offers barbed fittings in various plastics and in brass, compression fittings in PFA fluoropolymer, plastic cam-operated couplings and a variety of clamps. Ask for the Fittings & Clamps product catalog to see these items, or visit www.newageindustries.com.

Still can't find the fitting you need? Contact a representative about your requirements. ■

Newloc® Acetal

Plastic push-to-connect fittings . . . 2

Newloc® Brass

Brass push-to-connect fittings . . . 6



Plastic Push-To-Connect Fittings

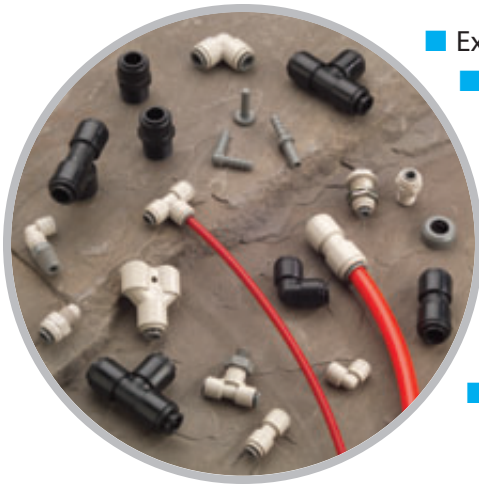

- Extremely easy to install — no tools necessary
- Certified by the National Sanitation Foundation (NSF-51 and NSF-61)†
- Instant leak-proof connections
- Made from tough, lightweight, FDA-sanctioned materials
- No flow restrictions
- Easy to disconnect and reuse
- Available in either Fractional or Metric sizes
- Optional collet cover to prevent accidental disconnection and to deter tampering — available in colors for coding purposes
- Genuine John Guest brand fittings



Notes

Construction materials:

Body: Acetal copolymer (fractions are gray; metrics are black)

'O'- Ring: FDA-grade nitrile rubber

Collet: Acetal copolymer with stainless steel teeth

Collet cover: Acetal copolymer

Working pressure: Up to 230 psi (air and potable liquids)**

Vacuum rating: Full (29.9 in./Hg)**

Working temperatures:

air: -4°F to 158°F**

potable liquids: 33°F to 158°F**

**Values listed are typical for the material used in manufacture, except where noted, and are meant only as a guide to aid in design. Field testing should be performed to find the actual values for your application.

Use NEWLOC ACETAL fittings with all types of semi-rigid to rigid plastic tubing including nylon and polyethylene. They can also be used in limited soft tubing sizes using tube supports — testing is recommended. Typical applications include systems for pneumatic control, food and beverage, chemicals, and potable water.

NEWLOC ACETAL's threads are self-sealing — do not use sealants such as fluoropolymer tape.

If tube and fitting are disconnected, it may be necessary to cleanly re-cut the end of the tubing at a 90° angle to ensure perfect sealing when reattached.

†NSF listed as trade designation "JG"

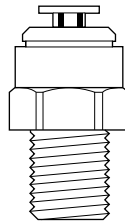

Male Adapter

Fraction (IN.)		Metric (MM)	
PART NO.	TUBE OD x NPT	PART NO.	TUBE OD x BSPT
520 0979	5/32 x 1/8	521 0723	4 x 1/8
520 1007	5/32 x 1/4	521 0751*	4 x 1/4
520 1035	3/16 x 1/8	521 0835	6 x 1/8
520 1063	1/4 x 1/8	521 0863	6 x 1/4
520 1091	1/4 x 1/4	521 0891	8 x 1/8
520 1098	1/4 x 3/8	521 0919	8 x 1/4
520 1119	5/16 x 1/8	521 0947	8 x 3/8
520 1147	5/16 x 1/4	521 0975	10 x 1/4
520 1175	5/16 x 3/8	521 1003	10 x 3/8
520 1203	3/8 x 1/8	521 1031	10 x 1/2
520 1231	3/8 x 1/4	521 1059*	12 x 3/8
520 1259	3/8 x 3/8	521 1087	12 x 1/2
520 1287	3/8 x 1/2		
520 1315	1/2 x 3/8		
520 1343	1/2 x 1/2		

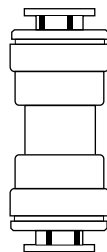

Union Connector

Fraction (IN.)		Metric (MM)	
PART NO.	TUBE OD	PART NO.	TUBE OD
520 1819	5/32	521 1423	4
520 1847	3/16	521 1451*	5
520 1875	1/4	521 1479	6
520 1903	5/16	521 1507	8
520 1931	3/8	521 1535	10
520 1959	1/2	521 1563	12

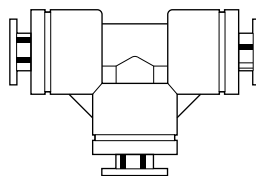

Union Tee

Fraction (IN.)		Metric (MM)	
PART NO.	TUBE OD	PART NO.	TUBE OD
520 4675	5/32	521 4335	4
520 4703	3/16	521 4363	5
520 4731	1/4	521 4391	6
520 4759	5/16	521 4419*	8
520 4787	3/8	521 4447	10
520 4815	1/2	521 4475	12

Swivel Male Branch Tee and **Swivel Male Run Tee** fittings may be assembled from components available — call for details.

*Limited stock availability; lead times and minimums may apply — call for details.
All items sold in increments of 10 pieces.

Plastic Push-To-Connect Fittings

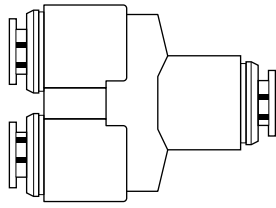

Union 'Y'

PART NO.	TUBE OD (IN.)
----------	---------------

520 4507	3/8
----------	-----

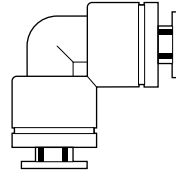

Union 90° Elbow

Fraction (IN.)		Metric (MM)	
PART NO.	TUBE OD	PART NO.	TUBE OD

520 3135	5/32	521 2767	4
520 3163	3/16	521 2823	6
520 3191	1/4	521 2851	8
520 3219	5/16	521 2879	10
520 3247	3/8	521 2907	12
520 3275	1/2		

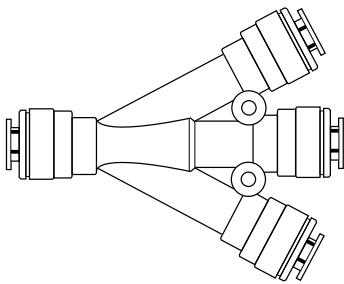

3-Way Union Connector

PART NO.	TUBE OD BRANCHES (IN.) x TUBE OD STEM (IN.)
----------	---

520 4633	3/8 x 1/2
----------	-----------



Tube Support

PART NO.	TUBE ID x TUBE OD (IN.)
----------	-------------------------

520 5487*	5/16 x 3/8
520 5515	3/8 x 1/2

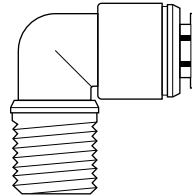

Male 90° Elbow

PART NO.	TUBE OD (IN.) x NPT
----------	---------------------

520 3331	1/4 x 1/8
520 3338	1/4 x 1/4
520 3345	1/4 x 3/8
520 3387	3/8 x 1/4

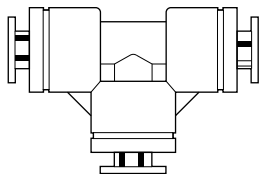

Reducing Union Tee

PART NO.	TUBE OD BRANCHES (IN.) x TUBE OD STEM (IN.)
----------	---

520 4955	1/2 x 3/8
----------	-----------

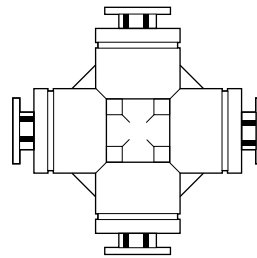

4-Way Union Connector

PART NO.	TUBE OD (IN.)
----------	---------------

520 4563	3/8
----------	-----

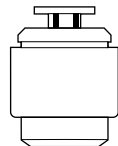

End Stop

PART NO.	TUBE OD (IN.)
----------	---------------

520 5865	3/8
----------	-----

*Limited stock availability; lead times and minimums may apply — call for details.
All items sold in increments of 10 pieces.

Plastic Push-To-Connect Fittings

Stem 90° Elbow

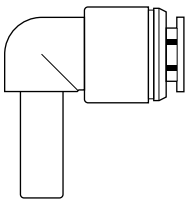

Fraction (IN.)		Metric (MM)	
PART NO.	STEM OD x TUBE OD	PART NO.	STEM OD x TUBE OD
520 2799	5/32 x 5/32	521 2431*	4 x 4
520 2827*	3/16 x 3/16	521 2459*	5 x 5
520 2855	1/4 x 1/4	521 2515*	8 x 8
520 2897*	3/8 x 3/16	521 2543*	10 x 10
520 2904	3/8 x 1/4	521 2571*	12 x 12
520 2911*	3/8 x 5/16		
520 2939	3/8 x 3/8		
520 2967	1/2 x 1/2		

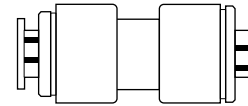

Reducing Union Connector

Fraction (IN.)		Metric (MM)	
PART NO.	TUBE OD x TUBE OD	PART NO.	TUBE OD x TUBE OD
520 2127	1/4 x 3/16	521 1759*	6 x 4
520 2183	5/16 x 3/16	521 1787*	8 x 4
520 2211	5/16 x 1/4	521 1815*	8 x 6
520 2239	3/8 x 3/16	521 1843*	10 x 4
520 2267	3/8 x 1/4	521 1871*	10 x 6
520 2295	3/8 x 5/16	521 1899*	10 x 8
520 2323	1/2 x 3/8	521 1927*	12 x 8
		521 1955*	12 x 10

Swivel Male 90° Elbow

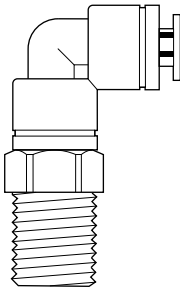

Fraction (IN.)		Metric (MM)	
PART NO.	TUBE OD x NPT	PART NO.	TUBE OD x BSPT
520 3779	5/32 x 1/8	521 3467	4 x 1/8
520 3807	5/32 x 1/4	521 3495	4 x 1/4
520 3835	3/16 x 1/8	521 3579	6 x 1/8
520 3863	1/4 x 1/8	521 3607	6 x 1/4
520 3891	1/4 x 1/4	521 3635	8 x 1/8
520 3919	5/16 x 1/8	521 3663	8 x 1/4
520 3947	5/16 x 1/4	521 3691	8 x 3/8
520 3975	5/16 x 3/8	521 3719	10 x 1/4
520 4003	3/8 x 1/4	521 3747	10 x 3/8
520 4031	3/8 x 3/8	521 3775	10 x 1/2
520 4059	1/2 x 3/8	521 3803	12 x 3/8
520 4087	1/2 x 1/2	521 3831	12 x 1/2

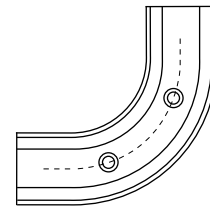

Flow Bend Clip

PART NO.	TUBE OD (IN.)
520 7223	5/16
520 7230	3/8

Male Stem Adapter

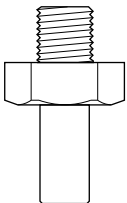

Fraction (IN.)		Metric (MM)	
PART NO.	STEM OD x NPT	PART NO.	STEM OD x BSPT
520 0027	5/32 x 1/8	521 0023	4 x 1/8
520 0111	1/4 x 1/8	521 0051	4 x 1/4
520 0139	1/4 x 1/4	521 0163	6 x 1/4
520 0167	5/16 x 1/8	521 0191	8 x 1/8
520 0195	5/16 x 1/4	521 0219	8 x 1/4
520 0223	5/16 x 3/8	521 0275	10 x 1/4
520 0251	3/8 x 1/4	521 0303	10 x 3/8
520 0279	3/8 x 3/8	521 0331*	10 x 1/2
520 0307	1/2 x 3/8	521 0359*	12 x 3/8
520 0335	1/2 x 1/2	521 0387*	12 x 1/2

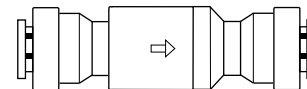

Check Valve

PART NO.	TUBE OD (IN.)
520 2001	3/8

*Limited stock availability; lead times and minimums may apply — call for details.
All items sold in increments of 10 pieces.

Plastic Push-To-Connect Fittings

Tube to Hose Barb

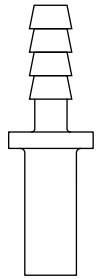

Fraction (IN.)		Metric (MM)	
PART NO.	STEM OD x HOSE ID	PART NO.	STEM OD x HOSE ID
520 0503	1/4 x 3/16		
520 0531	1/4 x 1/4	521 0583*	8 x 6
520 0559	1/4 x 5/16		
520 0587	5/16 x 3/16		
520 0643	5/16 x 5/16		
520 0671	5/16 x 3/8		
520 0699	3/8 x 1/4		
520 0727	3/8 x 5/16		
520 0755	3/8 x 3/8		
520 0762	3/8 x 1/2		
520 0783	1/2 x 3/8		
520 0811	1/2 x 1/2		

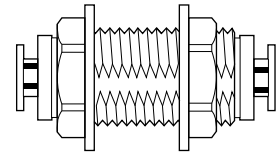

Bulkhead Union

Fraction (IN.)		Metric (MM)	
PART NO.	TUBE OD	PART NO.	TUBE OD
520 2491	5/32	521 2123*	4
520 2547	1/4	521 2179*	6
520 2575	5/16	521 2235*	10
520 2603	3/8	521 2263*	12
520 2631	1/2		

Plug

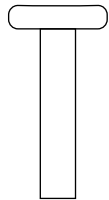

Fraction (IN.)		Metric (MM)	
PART NO.	STEM OD	PART NO.	STEM OD
520 5683*	5/32	521 5231*	5
520 5711	3/16	521 5259*	6
520 5739	1/4	521 5287*	8
520 5795	3/8	521 5315*	10
520 5823	1/2	521 5343*	12

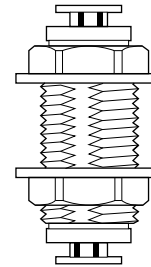

Reducing Bulkhead Union

PART NO.	TUBE OD (IN.) x TUBE OD (IN.)
520 2764	3/8 x 1/4

Female Adapter

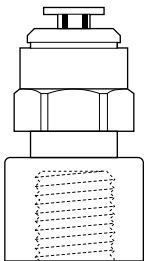

Fraction (IN.)		Metric (MM)	
PART NO.	TUBE OD x THREAD	PART NO.	TUBE OD x THREAD
520 0839*	3/8 x 1/4 FE FL	521 0639*	4 x 1/8 FE BSP
520 0881*	1/4 x 1/4 FNPT	521 0667*	8 x 1/4 FE BSP
520 0902*	3/8 x 1/4 FNPT		



Collet Retainer Clip

PART NO.	TUBE OD (IN.)
520 7139	1/4
520 7153	3/8

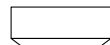

Collet Covers can prevent accidental disconnection and deter tampering on Newloc Acetal fittings (they will not fit Newloc Brass fittings). Collet Covers are available through special order in black, gray, red, blue, and yellow colors in the sizes listed at right — call for more information.

TUBE OD (IN.)	(MM)
5/32	
3/16	5
1/4	6
5/16	8
3/8	
1/2	12

*Limited stock availability; lead times and minimums may apply — call for details.

All items sold in increments of 10 pieces.

Brass Push-To-Connect Fittings



- Extremely easy to install — no tools necessary
- Made of durable brass — elbows and tees are forged
- Much higher temperature/pressure ratings than that of plastic Newloc
- No flow restrictions
- All male pipe threads come with a pre-applied fluoropolymer sealant
- Easy to disconnect and reuse



Made in U.S.A.

Notes

Construction materials:

Body & Collet: Brass

'O'- Ring: Buna-N (other materials available)

Working pressure:

Limited only by the working pressure of the plastic tubing used up to 250 psi**

Vacuum rating:

Full** (29.9 in./Hg)

Working temperature:

-10°F to 200°F** (higher temperatures are possible with special 'O'-rings — call for details)

**Values listed are typical for the material used in manufacture, except where noted, and are meant only as a guide to aid in design. Field testing should be performed to find the actual values for your application.

Use NEWLOC BRASS fittings with all types of semi-rigid to rigid plastic tubing including nylon and polyethylene. They may also be used with limited soft tubing sizes using tube supports (available). Pulling on the inserted tubing or increasing the pressure actually tightens the seal.

Typical applications include systems for pneumatic control, robotics, instrumentation, and chemicals.

Manifolds pre-mounted with NEWLOC BRASS fittings or nickel-plated NEWLOC BRASS (for improved aesthetics) are available — call for details.

All male pipe threads come with a pre-applied sealant of fluoropolymer, however for subsequent use it is recommended that sealant, such as PTFE Thread Sealant be used. The push-to-connect fitting ends are self-sealing — do not use sealants at this connection.

If tube disconnection is performed, it may be necessary to re-cut the end of the tubing to a 90° angle to ensure perfect sealing when reattached.

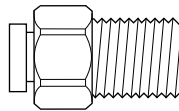

Male Adapter

PART NO.	TUBE OD (IN.) x THREAD
620 0103	1/8 x 1/16 NPTF
620 0110	1/8 x 1/8 NPTF
620 0012*	1/8 x 10-32 UNF
620 0145	5/32 x 1/8 NPTF
620 0159	5/32 x 1/4 NPTF
620 0019*	5/32 x 10-32 UNF
620 0026*	3/16 x 10-32 UNF
620 0243	1/4 x 1/8 NPTF
620 0257	1/4 x 1/4 NPTF
620 0271	1/4 x 3/8 NPTF
620 0033*	1/4 x 10-32 UNF
620 0369	3/8 x 1/8 NPTF
620 0383	3/8 x 1/4 NPTF
620 0397	3/8 x 3/8 NPTF
620 0404	3/8 x 1/2 NPTF
620 0439	1/2 x 1/4 NPTF
620 0446	1/2 x 3/8 NPTF
620 0453	1/2 x 1/2 NPTF

*Gasket supplied

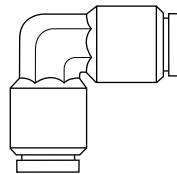

Union 90° Elbow

PART NO.	TUBE OD (IN.)
620 5738	1/8
620 5745	5/32
620 5759	1/4
620 5773	3/8
620 5780	1/2

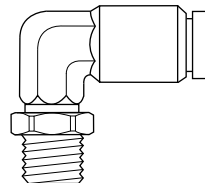

Swivel Male 90° Elbow

PART NO.	TUBE OD (IN.) x THREAD
620 4527	1/8 x 1/8 NPTF
620 4548	5/32 x 1/8 NPTF
620 4555	5/32 x 1/4 NPTF
620 4443*	5/32 x 10-32 UNF
620 4569	3/16 x 1/8 NPTF
620 4590	1/4 x 1/8 NPTF
620 4597	1/4 x 1/4 NPTF
620 4604	1/4 x 3/8 NPTF
620 4457*	1/4 x 10-32 UNF
620 4653	3/8 x 1/8 NPTF
620 4660	3/8 x 1/4 NPTF
620 4667	3/8 x 3/8 NPTF
620 4674	3/8 x 1/2 NPTF
620 4688	1/2 x 3/8 NPTF
620 4695	1/2 x 1/2 NPTF

*Gasket supplied

All items sold in increments of 5 pieces.

Brass Push-To-Connect Fittings

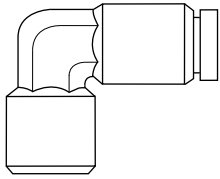

Female 90° Elbow

PART NO.	TUBE OD (IN.) x FNPT
620 5178	1/8 x 1/8
620 5199	5/32 x 1/8
620 5241	1/4 x 1/8
620 5248	1/4 x 1/4
620 5311	3/8 x 1/4

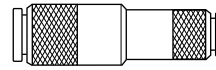

Reducing Union Connector

PART NO.	TUBE OD x TUBE OD (IN.)
620 1804	3/8 x 1/4

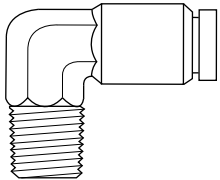

Male 90° Elbow

PART NO.	TUBE OD (IN.) x NPTF
620 4156	1/8 x 1/8
620 4177	5/32 x 1/8
620 4198	3/16 x 1/8
620 4219	1/4 x 1/8
620 4226	1/4 x 1/4
620 4233	1/4 x 3/8
620 4282	3/8 x 1/8
620 4289	3/8 x 1/4
620 4296	3/8 x 3/8
620 4317	1/2 x 3/8
620 4324	1/2 x 1/2

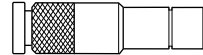

Reducer

PART NO.	STEM OD x TUBE OD (IN.)
620 8881	1/4 x 1/8

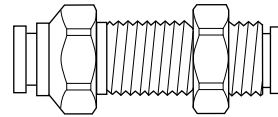

Bulkhead Union

PART NO.	TUBE OD (IN.)
620 3547	1/4
620 3561	3/8
620 3568	1/2

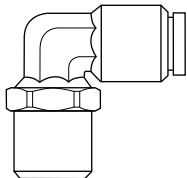

Swivel Female 90° Elbow

PART NO.	TUBE OD (IN.) x FNPT
620 5479	5/32 x 1/8
620 5521	1/4 x 1/8
620 5528	1/4 x 1/4
620 5591	3/8 x 1/4

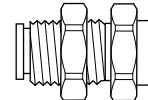

Female Bulkhead Union

PART NO.	TUBE OD (IN.) x FNPTF
620 3743	1/4 x 1/8
620 3757	1/4 x 1/4
620 3862	3/8 x 1/4

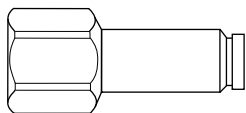

Female Adapter

PART NO.	TUBE OD (IN.) x FNPTF
620 2987	1/8 x 1/8
620 3120	1/4 x 1/8
620 3134	1/4 x 1/4
620 3246	3/8 x 1/4
620 3260	3/8 x 3/8

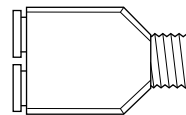

Male 'Y' Adapter

PART NO.	BRANCH TUBE OD (IN.) x STEM NPTF
620 2070	1/4 x 1/4

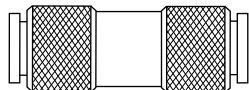

Union Connector

PART NO.	TUBE OD (IN.)
620 1566†	1/8
620 1573	5/32
620 1587	1/4
620 1601	3/8
620 1608	1/2

†Limited stock availability; lead times and minimums may apply — call for details.

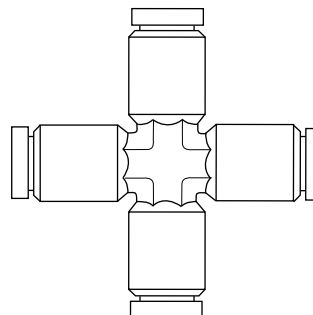

4-Way Union Connector

PART NO.	TUBE OD (IN.)
620 2903	1/8
620 2924	1/4

Brass Push-To-Connect Fittings

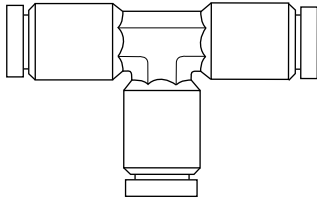

Union Tee

PART NO.	TUBE OD (IN.)
620 6508	1/8
620 6515	5/32
620 6529	1/4
620 6543	3/8
620 6550	1/2

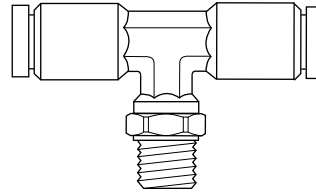

Swivel Male Branch Tee

PART NO.	TUBE OD (IN.) x STEM THREAD
620 7852	1/4 x 1/8 NPTF

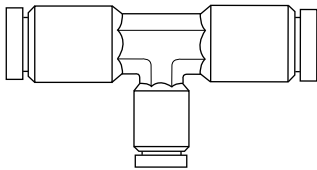

Reducing Union Tee

PART NO.	TUBE OD (IN.) x STEM OD
620 8538	3/8 x 1/4

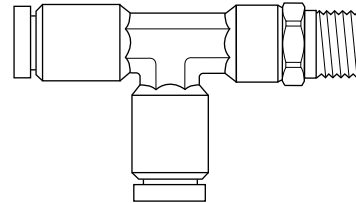

Swivel Male Run Tee†

PART NO.	TUBE OD (IN.) x BRANCH THREAD
620 7110	1/4 x 1/8 NPTF
620 7117	1/4 x 1/4 NPTF

†Limited stock availability; lead times and minimums may apply — call for details.

Meet Some of NewAge Industries' Owners

Through an Employee Stock Ownership Plan (ESOP), we're part owners in the company, and that makes *your* satisfaction an investment in *our* future.

ESOP Employee Owned
for Your Benefit



Kippy Baird
Receptionist/Admin.
Asst./Owner
13 years



Rich MacDonald
Network Administrator/Owner
11 years



Rattanak Seng
Silicone Molding/
Owner
8 years



Chris Kourelis
Warehouse
Manager/Owner
13 years



Sotharin Meth
Silicone Molding/
Owner
6 years



Ken Liszewski
Sales Project
Manager/Owner
17 years



Janine Clarkson
Document Control-
Quality/Owner
1 year



Chantha Cheng
Silicone Manu-
facturing/Owner
2 years



Seth Holtz
Warehouse/
Owner
1 year



Janet MacFarlane
Customer Service
Rep./Owner
5 years



Bill Keiser
Senior Quality
Auditor
6 years



Lorrie McGough
Accounting/Owner
16 years

Newloc, NewAge, "Fluid Transfer Specialists," and The "N" Logo are trademarks of NewAge® Industries, Inc.

WARRANTY: NewAge Industries' products are warranted to be free from defects in material and workmanship. Any product found to carry such defects will be replaced without charge. This warranty is limited only to the replacement of NewAge Industries' products, item for item, which after examination by NewAge Industries are deemed defective. NewAge Industries specifically disclaims any other liability. The data supplied is provided as a helpful guideline and is believed to be reliable; however, nothing stated shall constitute a guarantee, recommendation, or warranty for any application.

NOTICE: NewAge Industries, Inc. has been a privately owned corporation since 1954. Neither the corporation nor its principals are affiliated, in any way, with any other group or entity either representing themselves as or being referred to by the term NewAge.

© NewAge Industries, Inc. 2017 Specifications are subject to change without notice.

9/21/17

DISTRIBUTOR PARTNER



145 James Way
Southampton, PA 18966

www.newageindustries.com

800-50-NEWAGE
(800-506-3924)
215-526-2300

Fax: 800-837-1856
215-526-2190

info@newageindustries.com